

How to Build Pat's 4 Wheel Drive Robot Buggy, Arduino Uno R3, IR/Bluetooth, Smart Phone Controlled, Robot Buggy

Pat McMahon- V7- 18/5/2021

Design Brief– Using your Own Designed 3 Ply or Plastic Robot Base, Arduino Uno, IR/Bluetooth, Smart Phone Controlled, you will build and program your Robot Buggy to be controlled from an app on your Smart Phone or IR Remote. We will use an Arduino Uno R3, Shield, HC-05 and an L298N Motor Driver.

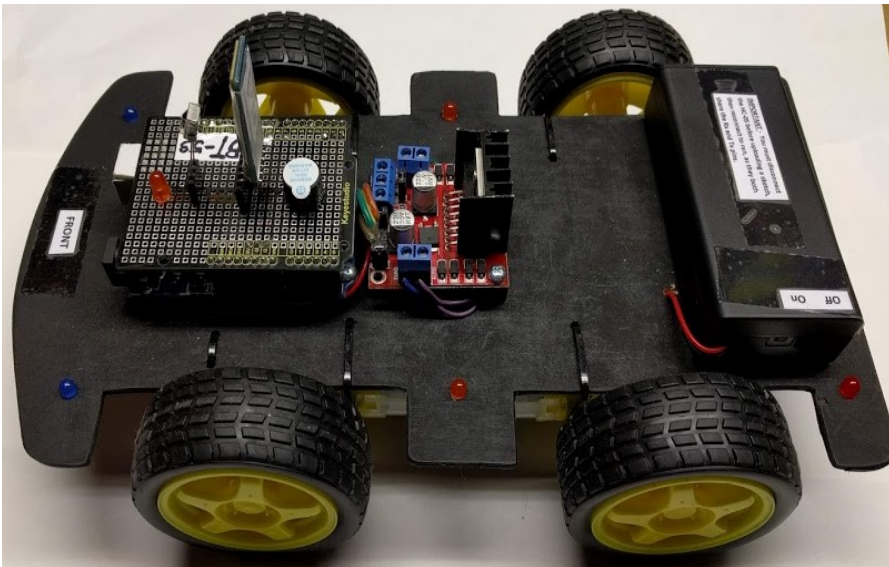

Free
Smart
Phone
Android
Apps

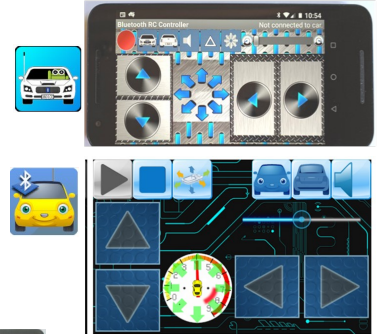

IR
Remotes

Below are some of the Production Steps, Tick off each box as you complete a task and Document it.

- Using a Laser Cutter or basic hand tools, design your own base using 3 Ply or Plastic. After checking the position of the Battery Pack, L298N and Uno, carefully Drill 6 x 4.8 mm diam holes, if you want front, back and middle LED's. (caution - if using plastic, it can easily break) All fastening holes for the Uno,L298N and Battery Pack are 3mm diameter.**

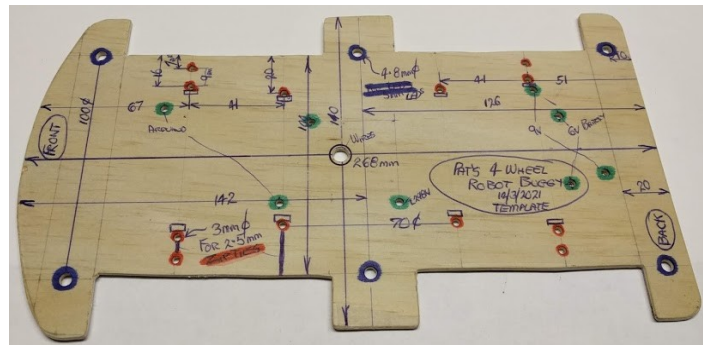
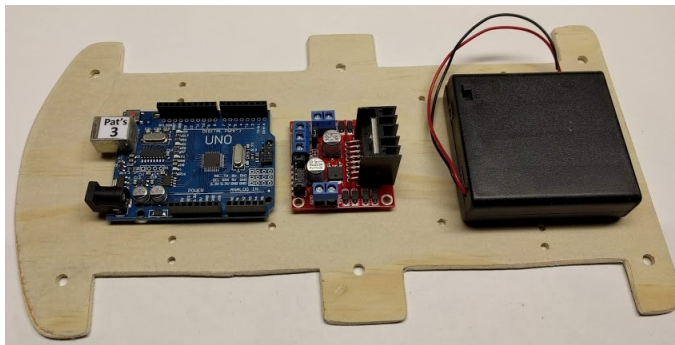

- I painted the top side on my 3 ply wooden base for appearance but left the underneath plain, for ease of seeing markings, assembly notes.**
- Press fit the 5 mm LED's into the base, soldering all the pairs of positive long Legs together. (Blue Front, Orange Middle, Red Back)**

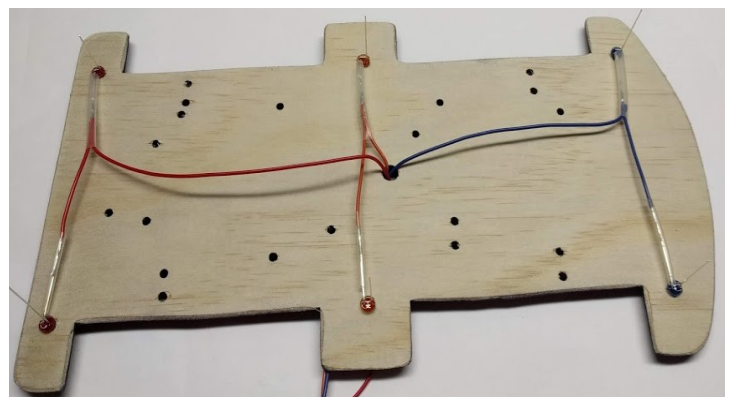

- Solder a common black wire to the LED short leg negatives. Lay tabs facing up on the 2 sets of 4 Motors.
Solder 150 mm long coloured wires onto the tabs.

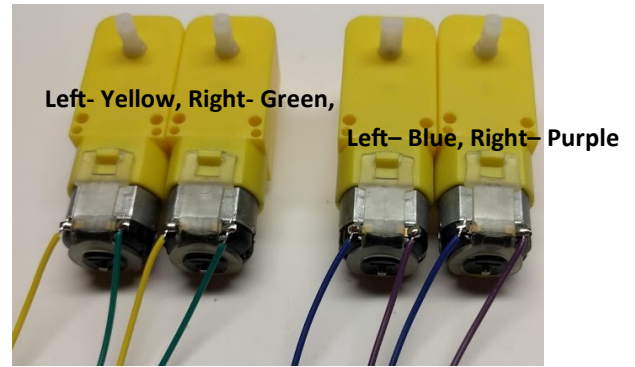
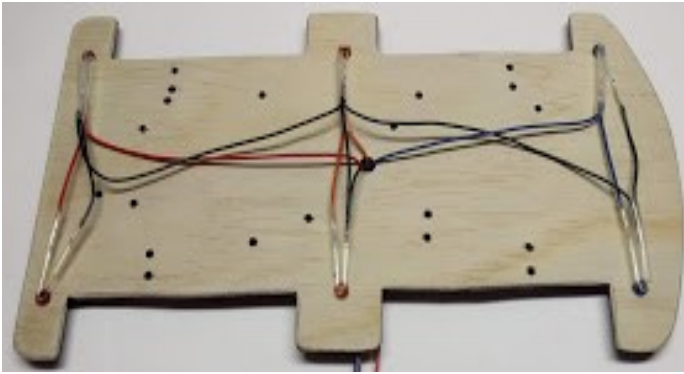

- As below, using 2.5 mm x 100 mm long Zip Ties, Fasten the motors securely to the base. With both Yellow/Green wires facing inwards, connect 2 Motors facing each other with Zip Ties, trimming excess. Once securely tight, repeat for the other side, Blue/Purple wired Motors.

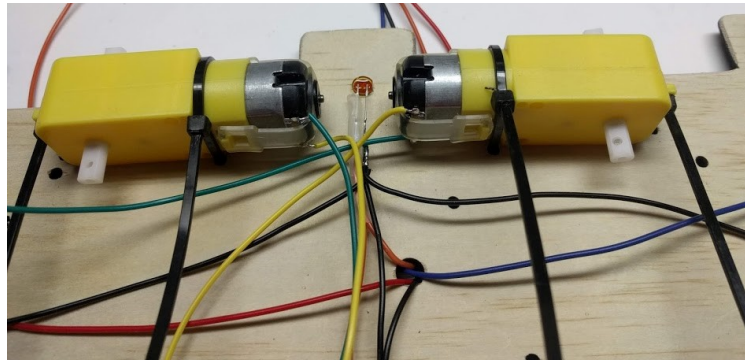

- Poke all coloured wires through the centre hole. Carefully press fit on the D shape shaft, the 4 wheels.

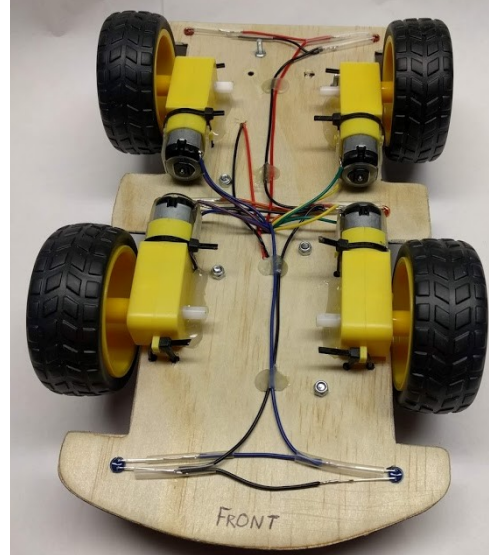
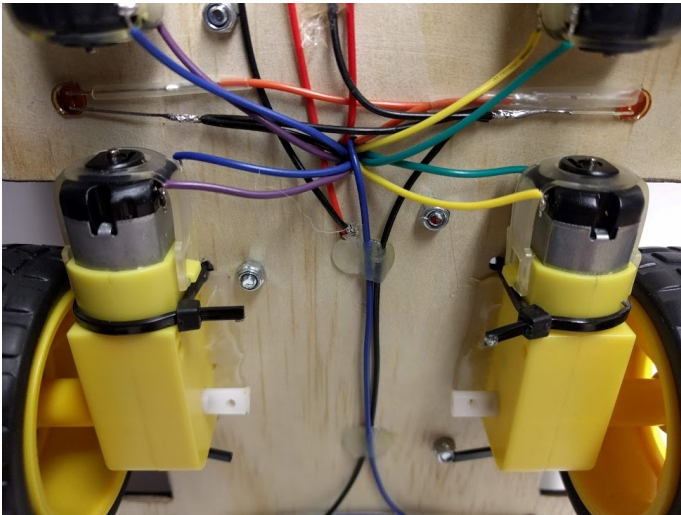

- As previously mentioned, fasten in position with 3 mm fasteners on the topside, on 10mm plastic risers, the Uno, L298N and Switched Battery Pack.

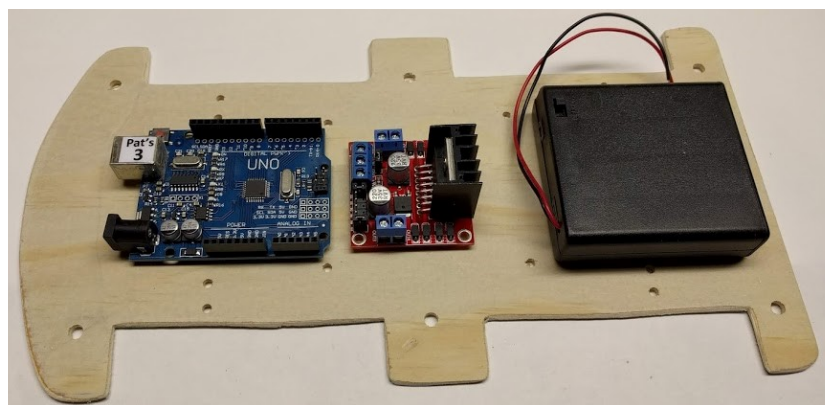

- Feed the wires from the LED's & Motors through the holes in the base, under the Uno & L298N.**

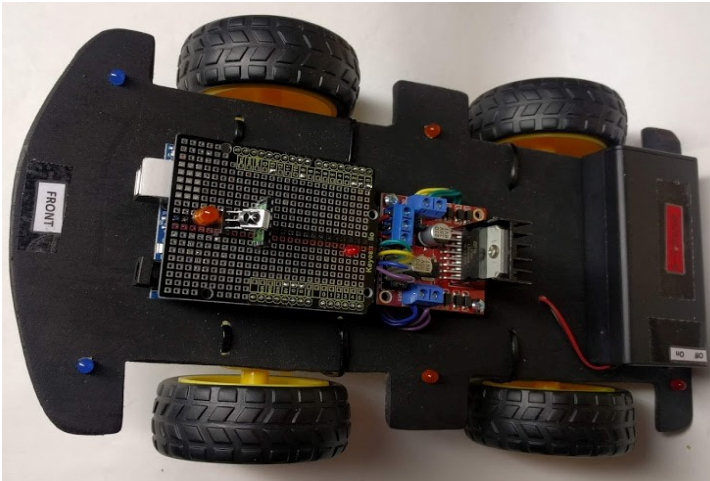

- Refer to the next page Main Info sheet before proceeding, explaining the overall basic wiring connections. Below are two options at this stage. The first uses lots of Dupont Wires or the second uses a hard wired Uno Shield. I found the hard wired Shield option my preferred option after prototyping, as sharp movements caused loose connections and problems with the Dupont Wires, especially the Bluetooth connections.**

Option 1 - Dupont Wires, No Shield

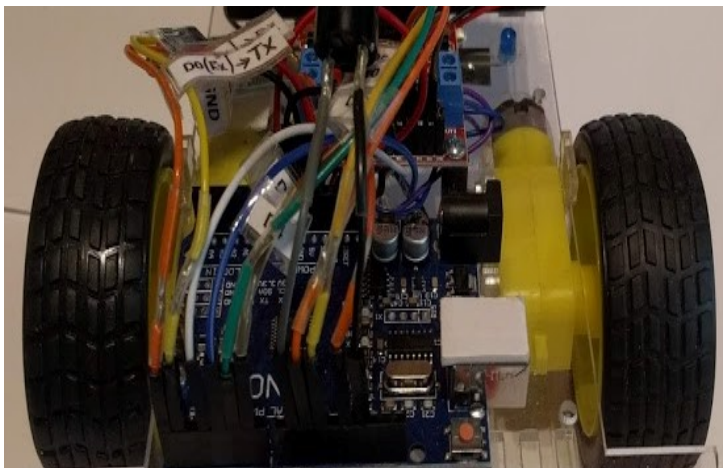

Option 2 - Hard Wired Shield

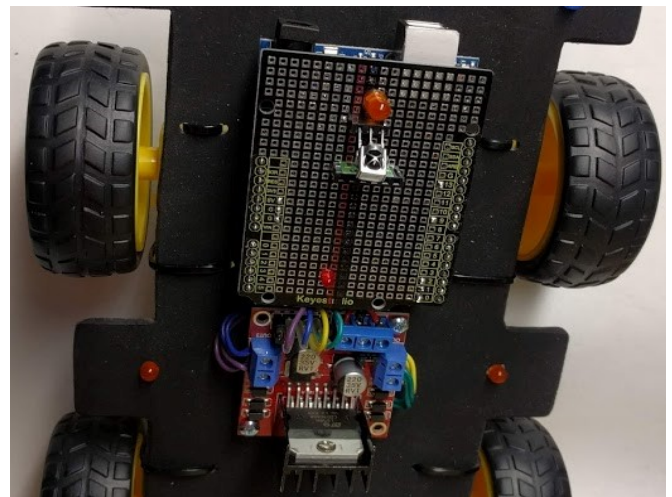

- If using option 1 or 2 above, (Refer to next Main Info page)**
- connect the 7.4V/ 9V Battery as shown to the L298N, Positive to 12V and Negative to Ground.
 - Connect Green Motor Wires to Out 1 on L298N
 - Connect Yellow Motor Wires to Out 2 on L298N
 - Connect Blue Motor Wires to Out 3 on L298N
 - Connect Purple Motor Wires to Out 4 on L298N

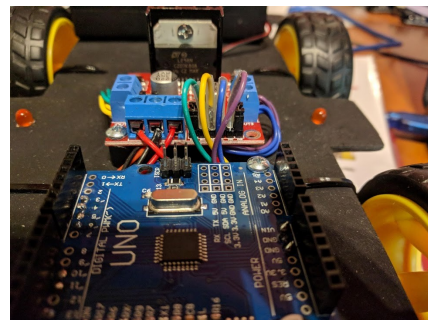

- If using option 1 above, connect the Dupont Wires as per the following Main Info Sheet to the Uno.**

If using option 2 above, you cannot place any wires in the Uno headers, as you are inserting the Shield on top of the Uno later. Insert the wires from underneath the Uno, next to the Header and solder them from the top side of the Uno.

- Connect the +5V out on L298N to the Vin on the Uno.
- Connect a Common Negative from the L298N Battery Negative to the Uno.

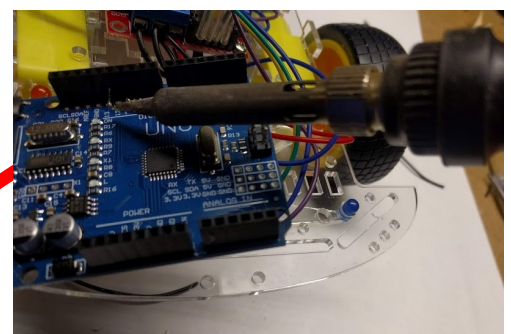

How to Connect your L298N Motor Driver, HC-05 Bluetooth & IR, to your Robot Buggy

<https://circuitbest.com/how-to-make-bluetooth-controlled-car-using-arduino/>

Pat McMahon—V7— 18/5/2021
For Scorpio Technology
Using 1 X 9V (6 x1.5V) Battery Pack

Go to Google Play and install the
Arduino Bluetooth RC Controller

NOTE - I modified the circuitbest code with LED's & Horn, to match the Bluetooth app.

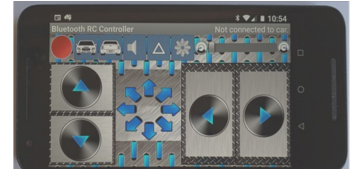
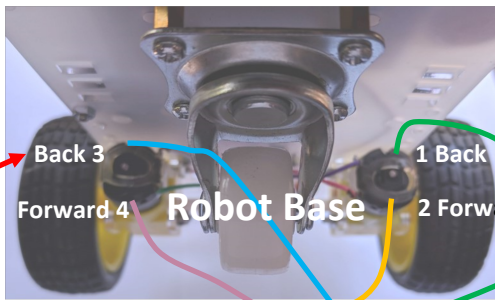

<https://play.google.com/store/apps/details?id=braulio.calle.bluetoothRCcontroller&hl=en>

Note— View underneath, looking from the rear end, towards the front, Motor tabs facing the centre.

IR Controllers

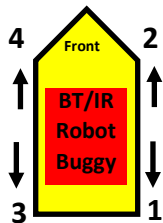

- 1— Open App.
- 2— Open Settings.
- 3— Connect to Car.
- 4— Select HC-05

The **RED** dot in the top left hand corner of your device will turn **GREEN** when connected and paired to Bluetooth.

HC-05 Bluetooth Module

(Outer Pins not used)

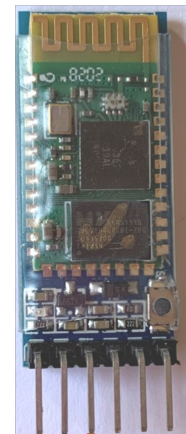

Rx Tx Gnd 5V

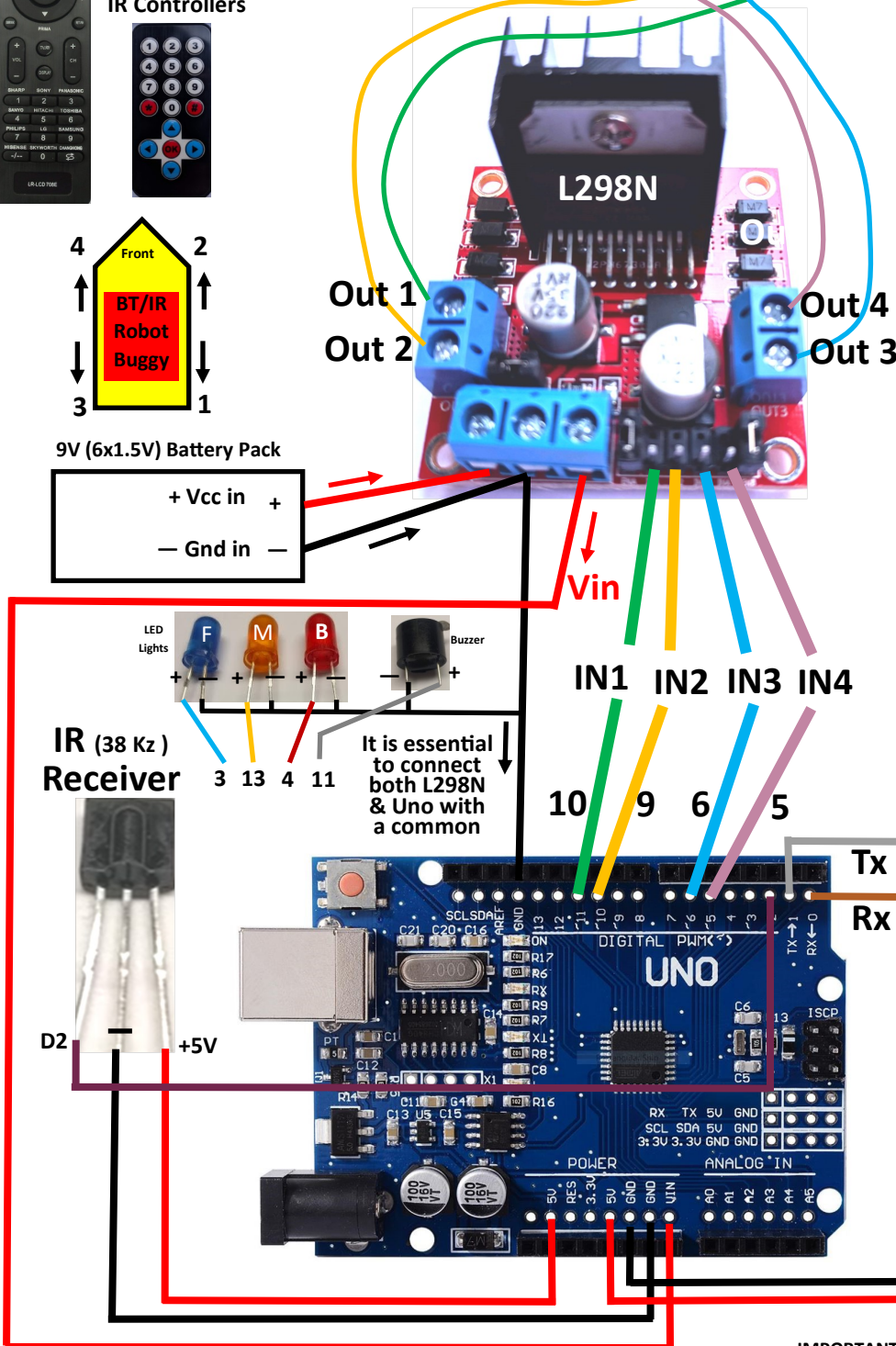

→ **Vin** power the UNO, IR & HC-05

IMPORTANT - You must disconnect the HC-05 before uploading a sketch, then reconnect to run, as they both share the Rx and Tx pins

Note- Diagrams not to Scale.

- ☐ **If using option 1 connect Dupont connectors into the Uno Headers or option 2, insert wires underneath and solder from above, (Refer to previous page Info)**

- Connect Green L298N Wire from IN1 to D10 on the Uno.
- Connect Yellow L298N Wire from IN2 to D9 on the Uno.
- Connect Blue L298N Wire from IN3 to D6 on the Uno.
- Connect Purple L298N Wire from IN4 to D5 on the Uno.

If using Option 1 with Dupont Wires.

- When looking at the IR Receiver from the front, connect the right leg +5V to 5V, middle leg — to Gnd, Left leg to D2 on the Uno.
- When looking at the HC-05 Module from the front, leave the 1st right leg unconnected, connect the 2nd right leg +5V to 5V, 3rd right leg Gnd to Gnd, 4th right leg Tx to RX, 5th right leg Rx to Tx on the Uno, left leg unconnected.
- Using an Active Buzzer, connect the short leg to Gnd, the long Leg to D11 on Uno.
- If connecting LED's, connect all — negatives with a common wire to Gnd, Front lights to D3, Middle Lights to D13 and Back Lights to D4.

- ☐ **If using Option 2 with Hard Wired to the Uno from underneath and a Shield ontop of the Uno.**

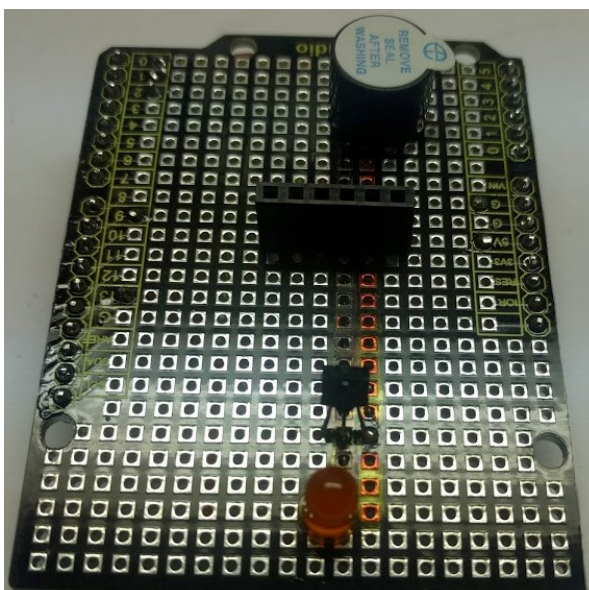

View from the top of the Shield

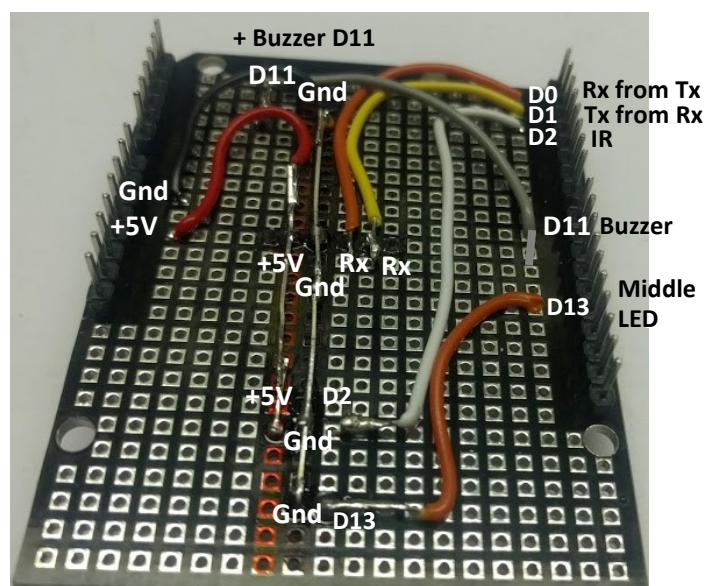

View from underneath the Shield

To minimise errors, with a permanent Texta, draw a Red + line and a Black — line as above on the top of the Shield and then carefully match on the corresponding underneath side of the Shield.

If using a header to easily remove the IR receiver and the Bluetooth HC-05, get a 10 pin Header, remove the 4th pin with a pair of pliers, then cut removed slot with a Stanley Knife then trim excess, giving a 6 (BT) and 3 (IR) Header. You can also if you prefer, hard solder the IR Receiver to the Shield.

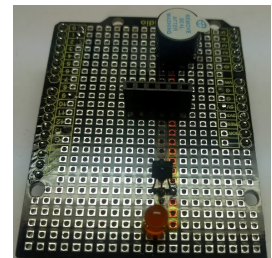
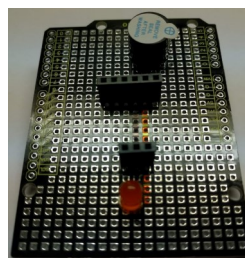
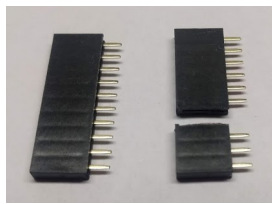
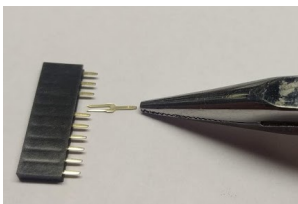

- When looking at the IR Receiver from the front, connect the right leg +5V to 5V, middle leg — to Gnd, Left leg to D2 on the Shield.
- When looking at the HC-05 Module from the front, leave the 1st right leg unconnected, connect the 2nd right leg +5V to 5V, 3rd right leg Gnd to Gnd, 4th right leg Tx to RX, 5th right leg Rx to Tx on the Shield, left leg unconnected.
- If using an Active Buzzer, connect the short leg to (—)Gnd, the long Leg (+) to D9 on the Shield.
- If connecting LED's, connect all (—) negatives with a common wire to Gnd, Front lights hard wired to D3 on Uno, Middle Lights to D13 on the Uno & top Light to the Shield and Back Lights hard wired to D4 on the Uno.

- By using the text info on the back blue side of the HC-05, with the HC-05 green side facing towards you and the USB end of the Uno, insert the HC-05 into the 6 Header. Double check your wiring again before powering up the HC-05 on the Buggy, so as to not cause permanent damage to the Module.

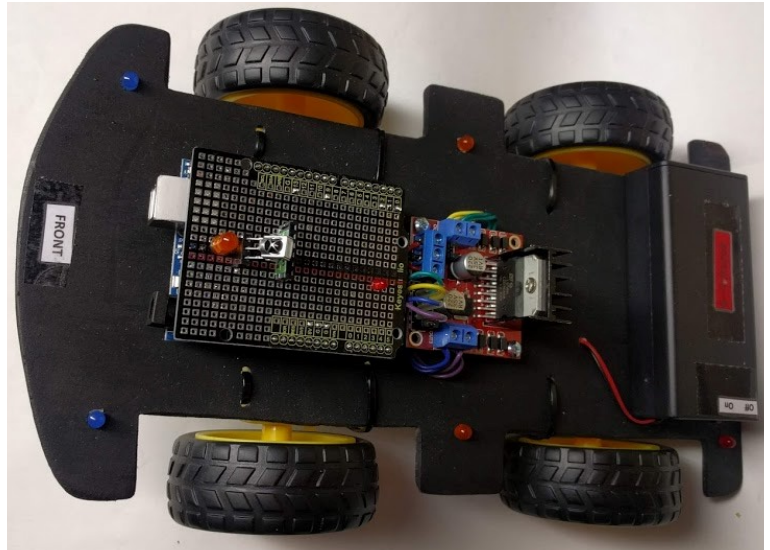
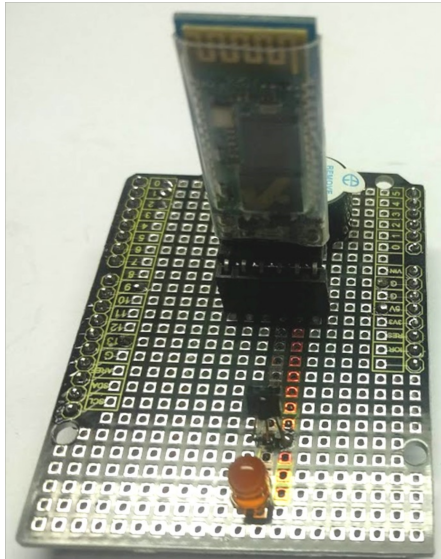

- Get your Smart Android Phone, go to Google Play store, download either of the free RC Car apps below. (try Both)

Initial Start Buttons

Goes from Red to Green when connected

Button Control

Accelerometer Control

Speed Slider Control

Both the above free apps for Android Smart Phones have Front, Back, Right & Left movement, Front Lights, Back Lights, Horn, Motor Power Speed. Both have Accelerometer Control with the Left one having an extra button for the Middle Lights .

<https://play.google.com/store/apps/details?id=braulio.calle.bluetoothRCcontroller&hl=en>

- 1– Open App.
- 2– Open Intial Start Button Settings.
- 3– Search for Devices ie HC-05.
- 3– Connect to Car.
- 4– Select HC-05

On the left app, the RED dot in the top left hand corner of your device will turn GREEN when connected and paired to Bluetooth. The right app will say Connected when ready.

- If using the Smart Phone or IR Remotes, upload Pat’s IR or Bluetooth Sketch to your Arduino Uno. Caution– From personal experience, always have the Robot Buggy safely on the ground when operating, especially when using the accelerometer control with your phone.

If using IR Remotes.



CONGRATULATIONS on Building and Programming your own IR/Bluetooth Smart Phone Controlled Robot Buggy!

IMPORTANT - You must disconnect the HC-05 before uploading a sketch, then reconnect to run, as they both share the Rx and Tx pins